



INSTRUCTION MANUAL

VHF dPMR MOBILE TRANSCEIVER
IC-F5062D

UHF dPMR MOBILE TRANSCEIVER
IC-F6062D



Icom Inc.

IMPORTANT

READ ALL INSTRUCTIONS carefully and completely before using the transceiver.

SAVE THIS INSTRUCTION MANUAL — This instruction manual contains important operating instructions for the **IC-F5062D VHF dPMR MOBILE TRANSCEIVER, IC-F6062D UHF dPMR MOBILE TRANSCEIVER.**

- This instruction manual includes some functions which are usable only when they are pre-programmed by your dealer. Ask your dealer for details.
- See the operating guide for details of BIIS (Binary Interchange of Information and Signaling) and dPMR (digital Private Mobile Radio) system operations. Ask your dealer for details.

EXPLICIT DEFENITIONS

WORD	DEFINITION
⚠ WARNING!	Personal injury, fire hazard or electric shock may occur.
CAUTION	Equipment damage may occur.
NOTE	If disregarded, inconvenience only. No risk of personal injury, fire or electric shock.

Icom, Icom Inc. and the Icom logo are registered trademarks of Icom Incorporated (Japan) in Japan, the United States, the United Kingdom, Germany, France, Spain, Russia and/or other countries.

All other products or brands are registered trademarks or trademarks of their respective holders.

PRECAUTIONS

⚠ WARNING! NEVER connect the transceiver to an AC outlet. This may pose a fire hazard or result in an electric shock.

⚠ WARNING! NEVER connect the transceiver to a power source of more than 16 V DC or use reverse polarity. This could cause a fire or damage the transceiver.

⚠ WARNING! NEVER cut the DC power cable between the DC plug and fuse holder. If an incorrect connection is made after cutting, the transceiver might be damaged.

CAUTION: NEVER place the transceiver where normal operation of the vehicle may be hindered or where it could cause bodily injury.

CAUTION: NEVER allow children to touch the transceiver.

CAUTION: NEVER expose the transceiver to rain, snow or any liquids.

USE the specified microphone only. Other microphones have different pin assignments and may damage the transceiver.

DO NOT use or place the transceiver in areas with temperatures below -25°C or above $+55^{\circ}\text{C}$, or in areas subject to direct sunlight, such as the dashboard.

DO NOT operate the transceiver without running the vehicle's engine. The vehicle's battery will quickly run out when the transceiver transmits while the vehicle's engine is OFF.

DO NOT place the transceiver in excessively dusty environments.

DO NOT place the transceiver against walls. Otherwise heat dissipation will be obstructed.

DO NOT use harsh solvents such as benzine or alcohol when cleaning, as they damage the transceiver surfaces.

BE CAREFUL! The transceiver will become hot when operating continuously for long periods.

VOICE CODING TECHNOLOGY

The AMBE+2™ voice coding Technology embodied in this product is protected by intellectual property rights including patent rights, copyrights and trade secrets of Digital Voice Systems, Inc. This voice coding Technology is licensed solely for use within this Communications Equipment. The user of this Technology is explicitly prohibited from attempting to extract, remove, decompile, reverse engineer, or disassemble the Object Code, or in any other way convert the Object Code into a human-readable form. U.S. Patent Nos.

#5,870,405, #5,826,222, #5,754,974, #5,701,390, #5,715,365, #5,649,050, #5,630,011, #5,581,656, #5,517,511, #5,491,772, #5,247,579, #5,226,084 and #5,195,166.

TABLE OF CONTENTS

IMPORTANT	i
EXPLICIT DEFENITIONS	i
PRECAUTIONS.....	ii
VOICE CODING TECHNOLOGY	iii
TABLE OF CONTENTS.....	iv
1 PANEL DESCRIPTION.....	1-7
■ Front panel	1
■ Function display	2
■ Programmable function keys	3
2 BASIC OPERATION.....	8-15
■ Turning the power ON	8
■ Channel selection.....	8
■ Call procedure.....	9
■ Receiving and transmitting.....	9
■ User Set mode	12
■ Emergency transmission	13
■ Scrambler function	14
■ Stun function	14
■ Priority A channel selection.....	14
■ Forced Narrow function	15
■ Automatic Key Lock function	15
■ Power Off Emergency function.....	15

3 CONNECTION AND MAINTENANCE	16-20
■ Rear panel connection	16
■ Supplied accessories	18
■ Mounting the transceiver	18
■ Antenna	19
■ Fuse replacement	19
■ Cleaning	19
■ Options.....	20
4 DOC	21-23

1

PANEL DESCRIPTION

■ Front panel

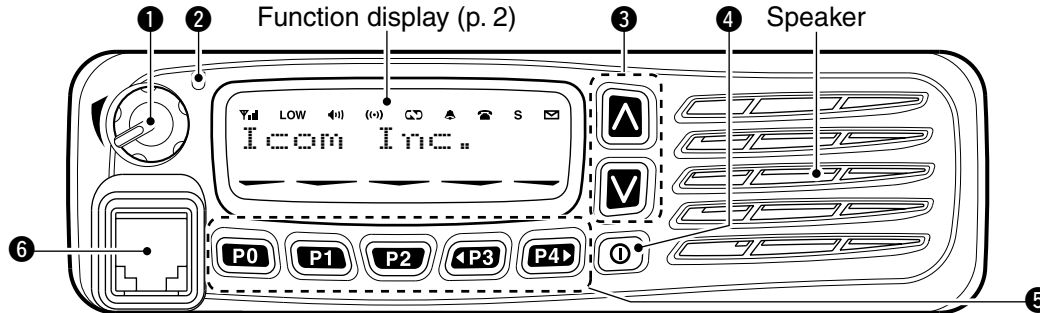

① AF VOLUME CONTROL KNOB [VOL]

- Rotate the knob to adjust the audio output level.
- Minimum audio level is preprogrammed.

② LED INDICATOR

- ➔ Lights red while transmitting a signal.
- ➔ Lights green while receiving a signal.

③ UP/DOWN KEYS [CH Up]/[CH Down]

- Push to select an operating channel, etc.
- *Required functions can be assigned by your dealer. (p. 3)

④ POWER SWITCH [D]

- Hold down for 1 second to turn the power ON or OFF.
- Automatic scan start, Password prompt and User Set mode access are available at power ON.

⑤ DEALER-PROGRAMMABLE KEYS

- Required functions can be programmed independently by your dealer. (p. 3)

⑥ MICROPHONE CONNECTOR

Connect the supplied or optional microphone.

NEVER connect non-specified microphones. The pin assignments may be different and may damage the transceiver.

◇ MICROPHONE

- The supplied microphone has a PTT switch and a hanger.
- The following functions are available when you put the microphone ON hook, or take it OFF hook (depending on the pre-programmed settings):
 - Automatic scan starts when you put it ON hook.
 - Scan is paused or cancelled when you take it OFF hook.
 - Automatically selects the Priority A channel when you take it OFF hook.
 - Sets to the 'Inaudible' (mute) mode when you put it ON hook.
 - Sets to the 'Audible' (unmute) mode when you take it OFF hook.

Function display

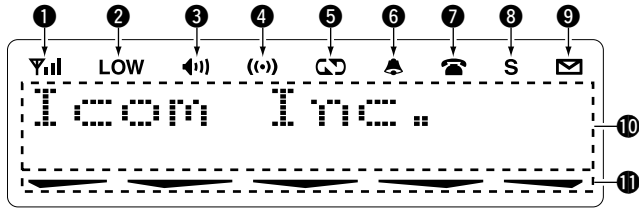

1 SIGNAL STRENGTH ICON

Shows relative receive signal strength level.



Weak ← Receive Signal level ⇒ Strong

2 LOW POWER ICON

Appears when low output power is selected.

3 AUDIBLE ICON

➔ Appears when the channel is in the 'Audible' (unmute) mode.

➔ Appears when a matching signal is received.

4 COMPANDER ICON

Appears when the Compander function is activated.

5 SCRAMBLER ICON

Appears when the Voice Scrambler function is activated.

6 BELL ICON

Appears/blinks when a matching signal is received, depending on the pre-programmed settings.

7 CALL CODE MEMORY ICON

Appears when the call code memory is selected.

8 SCROLL ICON

Appears when an SDM (Short Data Message), including more than 12 characters, is selected in the received message selection mode*^{1, 2}.

9 SDM ICON

Appears when an SDM is received, or an SDM is selected to transmit*^{1, 2}.

10 ALPHANUMERIC DISPLAY

➔ Displays an operating channel number, channel name, User Set mode contents, DTMF code, etc.

➔ Depending on the pre-programmed settings, characters are displayed in 1 line or 2 lines on the LCD.

- In this instruction manual, the LCD illustration is described as having characters displayed in 2 lines.

11 ACTIVATED KEY ICON

Appears above the key assigned as [Scan], [Scan Add/Del(Tag)], [Lock], [Talk Around], [Surveillance] and [BIIS Button]*¹, while that key is activated.

*¹ BIIS operation only

*² dPMR operation only

▨ See the operating guide for details of BIIS and dPMR system operations. Ask your dealer for details.

1 PANEL DESCRIPTION

■ Programmable function keys

The following functions can be assigned to [UP], [DOWN], [P0], [P1], [P2], [P3] and [P4] programmable function keys. Consult your Icom dealer or system operator for details concerning your transceiver's programming.

If the programmable function names are bracketed in the following explanations, the specific key is used to activate the function, depending on the pre-programmed settings.

INFORMATION:

Depending on the pre-programmed settings, the programmed function for [P0], [P1], [P2] or [P3] is assigned to [A], [B], [C] or [D] of the optional HM-152T, respectively. Ask your dealer for details.

CHANNEL UP, CHANNEL DOWN

- ➔ Push to select an operating channel.
- ➔ As described in the following topics, after pushing a programmed key, push [CH Up] or [CH Down] to select an option, setting, etc.

ZONE

Push this key, then push [CH Up] or [CH Down] to select the desired zone.

 **What is “zone”?**—Certain channels are grouped together and assigned to a zone, according to their intended use. For example, ‘Staff A’ and ‘Staff B’ are assigned to a “Business” zone, and ‘John’ and ‘Cindy’ are assigned to a “Private” zone.

ZONE UP, ZONE DOWN

Push to select an operating zone.

SCAN

- ➔ Push to start or cancel a scanning operation.
 - When a scan is started by the Power ON Scan or Automatic Scan function, push this key to cancel the scan. The cancelled scan resumes after the pre-programmed time period.
- ➔ Hold down this key for 1 second to display the scan group, then push [CH Up] or [CH Down] to select the desired one.

SCAN ADD/DEL (TAG)

- ➔ Push to add the selected channel to, or delete it from, the scan group.
 1. Push to display the scan group, and then push [CH Up] or [CH Down] to select the desired one.
 2. Push to add the channel to, or delete it from, the selected scan group.
 3. Hold down for 1 second to exit the scan group selection mode.
- ➔ While a scan is paused on a non-priority channel, push this key to delete the selected channel from the scan group.

 Depending on the pre-programmed settings, the cleared channel is added to the scan group again after the scan is cancelled. (Nuisance Delete function)

PRIORITY A, PRIORITY B

Push to select the Priority A or Priority B channel.

PRIORITY A (REWRITE), PRIORITY B (REWRITE)

- Push to select the Priority A or Priority B channel.
- Hold down for 1 second to assign the operating channel to the Priority A or Priority B channel.

MEMORY CHANNELS 1, 2, 3, 4

Push to select memory channel 1, 2, 3 or 4.

MONITOR, MONITOR (AUDIBLE)

- Push to turn the CTCSS (DTCS) or 2/5-tone squelch mute ON or OFF.
 - Only during LMR (Land Mobile Radio) operation, push to open any squelch, or deactivate any mute functions.
 - Only during PMR (Private Mobile Radio) operation, push to activate one or two of the following functions on each channel (Depending on the pre-programmed settings):
 - Hold down to unmute the channel ('Audible' mode).
 - Push to mute the channel ('Inaudible' mode).
 - After the communication is finished, push to send a 'reset code' (5-tone) or a 'Clear Down' signal (BIS).
-  **NOTE:** The 'Audible' (unmute) mode may automatically return to the 'Inaudible' (mute) mode, after the pre-programmed time period.

- Depending on the pre-programmed settings, holding down this key for 1 second cancels a scan.

PUBLIC ADDRESS

Push to activate the PA (Public Address) function. When this function is turned ON, the audio level can be separately controlled from the transceiver by pushing [CH Up] or [CH Down].

- This function can be used when external equipment, such as an audio amplifier, speaker, etc. is connected.
- Push this key, then hold down [PTT] and speak into the microphone.

RX SPEAKER

Push to turn the RX Speaker function ON or OFF.

When this function is turned ON, the received audio can be heard through an external speaker.

- This function is useful when you are away from the transceiver.
- The audio output level is linked to the transceiver's volume control.

LIGHT

Push to turn the backlight ON for about 5 seconds, when the Backlight function is set to "OFF" in the User Set mode.

LOCK

- Hold down this key until "LOCK ON" is displayed to electronically lock all programmable keys except the following: [Moni], [Light], [Lock], [Call] (incl. Call A and Call B), [Emergency], [Surveillance], [Lone Worker] and [OPT 1/2/3].
- When the Key Lock function is ON, hold down this key until "LOCK OFF" is displayed to turn it OFF.

1 PANEL DESCRIPTION

LONE WORKER

Push to turn the Lone Worker function ON or OFF.

- If the Lone Worker function is turned ON, and no operation occurs during the pre-programmed time period, the Emergency function is automatically turned ON.

HIGH/LOW

Push to select the transmit output power level temporarily or permanently, depending on the pre-programmed settings.

- Ask your dealer for the output power level for each selection.

TONE/COLOUR CODE CH SELECT

- ➔ While in the analog mode, push to enter the continuous tone selection mode. Then push [CH Up] or [CH Down] to select the desired tone frequency/code setting. After selecting, push this key again to store the setting.
- ➔ While in the digital mode, push to enter the colour code selection mode. Then push [CH Up] or [CH Down] to select the desired colour code. After selecting, push this key again to store the setting.
- ➔ While in the mixed (digital and analog) mode, push to enter the continuous tone selection mode. Then push [CH Up] or [CH Down] to select the desired tone frequency/code setting. After selecting, push this key to store the setting. After that, the colour code selection screen appears. Push [CH Up] or [CH Down] to select the desired colour code. After selecting, push this key again to store the setting.

C.TONE CH ENT

Push to enter the continuous tone channel selection mode. Then push [CH Up] or [CH Down] to select the desired tone frequency/code setting. The selected channel remains set until another channel is designated.

TALK AROUND

Push to turn the Talk Around function ON or OFF.

- The Talk Around function equalizes the transmit frequency to the receive frequency for transceiver-to-transceiver communication.

WIDE/NARROW

Push to switch the IF bandwidth between wide and narrow.

- The wide passband width is pre-programmed to either 25.0 or 20.0 kHz by your dealer (PMR operation only).

DTMF AUTODIAL

Push to enter the DTMF channel selection mode, then push [CH Up] or [CH Down] to select a desired DTMF channel. After selecting, push again to transmit the selected DTMF code.

RE-DIAL

Push to transmit the last-transmitted DTMF code.

- TX memories are cleared after turning the power OFF.

CALL, CALL A, CALL B

Push to transmit a 2/5-tone code or BIIS/dPMR call.

- Call transmission is necessary before calling another station, depending on your signalling system.
- [Call A] and/or [Call B] may be available when your system employs selective 'Individual/Group' calls. Ask your dealer which call is assigned to each key.

EMERGENCY

Hold down for the pre-programmed time period to enter the emergency mode. After the pre-programmed time period, an Emergency call is transmitted once, or repeatedly*. (p. 13)

- To exit the emergency mode, hold down this key for the pre-programmed time period again, before transmitting.
- * Depending on the pre-programmed settings.

SURVEILLANCE

Push to turn the Surveillance function ON or OFF.

When this function is turned ON, the beep does not sound and the LCD backlight and the LED indicator do not light, even when a signal is received or a key is pushed.

TX CODE ENTER

Push to enter the TX code edit mode (5Tone) (p. 11) or the ID code edit mode (BIIS, dPMR), and then set the desired TX code or ID code.

TX CODE CHANNEL SELECT

- ➔ Push to enter the TX code channel selection mode (p. 10) or the ID selection mode (BIIS, dPMR), and then push [CH Up] or [CH Down] to select the desired channel or ID.
- ➔ Hold down this key for 1 second to enter the TX code edit mode (5Tone) (p. 11) or the ID code edit mode (BIIS, dPMR), and then set the desired TX code or ID code.

TX CODE CHANNEL UP, TX CODE CHANNEL DOWN

Push to select a TX code channel (p. 10) or ID (BIIS, dPMR).

SCRAMBLER

Push to turn the Voice Scrambler function ON or OFF.

COMPANDER

Push to turn the Compander function ON or OFF.

The Compander function reduces noise components from the transmitted audio to provide clear communication.

ID-MR SELECT

- ➔ Recalls detected ID codes.
 - Push this key, then push [CH Up] or [CH Down] to select the ID code.
 - Up to 5 IDs are memorized.
- ➔ Hold down for 1 second to erase the selected ID.

/// See the operating guide for details of BIIS and dPMR system operations. Ask your dealer for details.

1 PANEL DESCRIPTION

HOOK SCAN

When the Hook Scan function is pre-programmed, push this key to disable the function. Push this key again to enable the function.

USER SET MODE

- Hold down for 1 second to enter the User Set mode.
 - In the User Set mode, push this key to select an item that is enabled by your dealer, and change the value or setting by pushing [CH Up] or [CH Down].
- Hold down for 1 second again to exit the User Set mode.

The User Set mode is also available using the Power ON function. Refer to page 12.

10Key ENT

Push to enable the microphone's 10-keypad operation.

- Depending on the pre-programmed settings, 10-keypad can be used to select a desired memory channel, ID list number (dPMR), TX status (BIIS, dPMR) or Short Data Message (dPMR), or enter a desired TX code (5-tone) or ID (dPMR).

OPT 1 OUT, OPT 2 OUT, OPT 3 OUT

Push to output the control signal to the option connector. Ask your dealer for details.

OPT 1 MOMENTARY, OPT 2 MOMENTARY, OPT 3 MOMENTARY

Outputs the control signal to the option connector while holding down this key. Ask your dealer for details.





POWER OFF EMERGENCY

While holding down this key, turn the power OFF to activate the Power OFF Emergency function.

This function makes the transceiver transmit emergency calls, even though it appears to be powered OFF. (p. 15)

■ Turning the power ON

- ① Hold down [⓪] for 1 second to turn the power ON.
- ② If the transceiver is programmed for a start up password, input the digit codes as directed by your dealer.
 - The keys as below can be used for password input:
The transceiver detects numbers in the same block as identical. Therefore “01234” and “56789” are the same.

KEY					
NUMBER	0	1	2	3	4
	5	6	7	8	9

- ③ When the “PASSWORD” indication does not clear after inputting 6 digits, the input code number may be incorrect. Turn the power OFF and start over, in this case.

■ Channel selection

Several types of channel selection are available. Methods may differ, according to your system set up.

NON-ZONE TYPE:

To select the desired operating channel:

- Push [CH Up] or [CH Down].
- Push one of [MR-CH 1] to [MR-CH 4].

ZONE TYPE:

To select the desired zone:

- Push [Zone], then push [CH Up] or [CH Down].
- Push [Zone Up] or [Zone Down].

◇ **Voting operation**

The transceiver automatically starts scanning when a zone, specified for the voting operation, is selected.

The voting scan detects the signal strength of the repeaters, and automatically selects the strongest one.

AUTOMATIC SCAN TYPE:

Channel setting is not necessary for this type. When turning the power ON, the transceiver automatically starts scanning. Scanning stops when receiving a call.

2 BASIC OPERATION

■ Call procedure

When your system employs tone signalling (excluding CTCSS and DTCS), a call procedure may be necessary prior to voice transmission. The tone signalling employed may be a selective calling system, which allows you to call specific station(s) only, and prevent unwanted stations from contacting you.

- ① Select the desired TX code channel according to your system operator's instructions.
 - This may not be necessary, depending on programming.
 - Refer to pages 10 and 11 for details.
- ② Push [Call] (assigned to one of the dealer programmable keys).
- ③ After transmitting, the remainder of your communication can be carried out in the normal fashion.

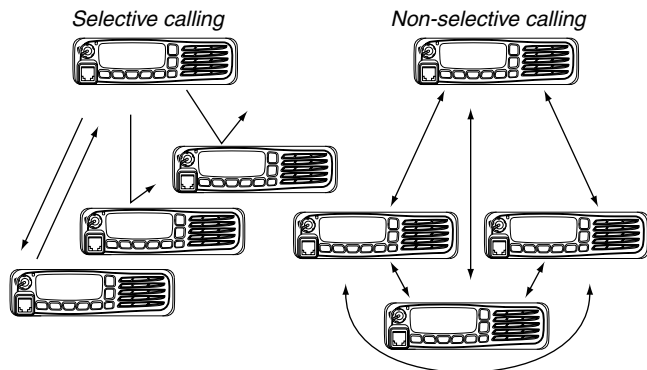

■ Receiving and transmitting

Receiving:

- ① Hold down [Ⓜ] for 1 second to turn the power ON.
- ② Push [CH Up] or [CH Down] to select a channel.
- ③ When receiving a call, rotate [VOL] to adjust the audio output level to a comfortable listening level.

NOTE: Depending on the pre-programmed settings, the transceiver automatically transmits the microphone audio for the pre-programmed time period when a matching signal is received.

- The HM-148G or HM-152 HAND MICROPHONE is required.

Transmitting:

Wait for the channel to become clear to avoid interference.

- ① Take the microphone OFF hook.
 - 2/5-tone mute may be released. (The 'Audible' (unmute) mode is selected and LED indicator lights green.)
 - The Priority A channel may be automatically selected.
- ② Wait for the channel to become clear.
 - The channel is busy when the LED indicator lights green.
- ③ While holding down [PTT], speak into the microphone at your normal voice level.
- ④ Release [PTT] to return to receive.

IMPORTANT: To maximize the readability of your signal;

1. Pause briefly after pushing [PTT].
2. Hold the microphone 5 to 10 cm from your mouth, then speak into the microphone at a normal voice level.

◇ Transmitting notes

• Transmit inhibit function

The transceiver has several inhibit functions which restrict transmission under the following conditions:

- The channel is in the 'Inaudible' (mute) mode (“”) (Audible icon) does not appear.)
- The channel is busy. However, depending on the pre-programmed settings, you can transmit when a call is received that includes an unmatching (or matching) CTCSS (DTCS), colour code, or Individual or Talkgroup ID.
- The selected channel is a 'receive only' channel.

• Time-out timer

If continuous transmission exceeds the pre-programmed time-out timer limit, the transmission is cut off.

• Penalty timer

After the transmission is cut off by the time-out timer, transmission is further inhibited for the pre-programmed penalty timer period.

◇ TX code channel selection

If the transceiver has a key assigned to TX Code CH Select, the indication can be toggled between the operating channel number (or name) and TX code channel number (or name). When the TX code channel number (or name) is displayed, [CH Up] or [CH Down] selects the TX code channel.

USING [TX CODE CH SELECT]:

- ① Push [TX Code CH Select]— a TX code channel number (or name) appears.
- ② Push [CH Up] or [CH Down] to select the desired TX code channel.
- ③ After selecting, push [TX Code CH Select] to set.
 - Return to the stand-by mode.
- ④ Push [Call] to transmit the selected TX code.

USING [TX CODE CH UP]/[TX CODE CH DOWN]:

If the transceiver has a key assigned to TX Code CH Up or TX Code CH Down, the programmed TX code channel can be directly selected when pushed.

2 BASIC OPERATION

◇ TX code edit (5-tone operation only)

If the transceiver has a key assigned to TX Code CH Select or TX Code Enter, TX code contents can be edited within the allowable digits.

USING [TX CODE CH SELECT]:

- ① Push [TX Code CH Select] to enter the TX code channel selection mode.
 - Select the desired channel before entering the TX code channel selection mode, if necessary.
- ② Hold down [TX Code CH Select] for 1 second to enter the TX code edit mode.
 - The digit to be edited blinks.
- ③ Push [TX Code CH Select] to select the desired digit to be edited.
- ④ Push [CH Up] or [CH Down] to set the desired digit.
- ⑤ Push [TX Code CH Select] to set. The digit to the right will automatically blink.
- ⑥ Repeat steps ④ and ⑤ to edit all allowable digits.
- ⑦ After editing, push [TX Code CH Select] to set.
 - Return to the stand-by mode.
- ⑧ Push [Call] to transmit.

USING [TX CODE ENTER]:

- ① Push [TX Code Enter] to enter the TX code edit mode.
 - The digit to be edited blinks.
- ② Push [TX Code Enter] to select the desired digit to be edited.
- ③ Push [CH Up] or [CH Down] to select the desired digit.
- ④ Push [TX Code Enter] to set. The digit to the right will automatically blink.
- ⑤ Repeat steps ③ and ④ to input all allowable digits.
- ⑥ After editing, push [TX Code Enter] to set.
 - Return to the stand-by mode.
- ⑦ Push [Call] to transmit.

◇ DTMF transmission

If the transceiver has a key assigned to DTMF Autodial, the automatic DTMF transmission function is available. Up to 8 DTMF channels are selectable.

- ① Push [DTMF Autodial]— a DTMF channel appears.
- ② Push [CH Up] or [CH Down] to select the desired DTMF channel.
- ③ Push [DTMF Autodial] to transmit the DTMF code.

■ User Set mode

The User Set mode can be accessed with the Power ON function. In this case, all items are selectable.

The User Set mode allows you to set seldom-changed settings and you can “customize” the transceiver operation to suit your preferences and operating style.

/// **NOTE:** While in the User Set mode, [Up], [Down] and [P0] activate regardless of the assigned key functions.

Entering the User Set mode:

- ① While holding down [P1] and [P2], push [P0] to turn the power ON.
 - Turn the power OFF first.
 - You should hold down [P1] and [P2] until “SET MODE” appears on the display.

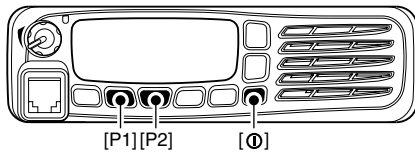

- ② Hold down [P0] for 1 second to enter the User Set mode.

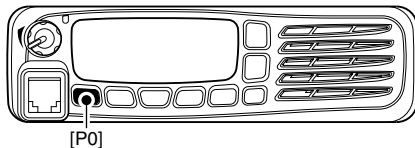

- ③ Push [P0] several times to select the appropriate item. Then, push [Up] or [Down] to set the desired value or setting.

- Available User Set mode items are **Backlight, LCD Contrast, Beep, Beep Level, Ringer Level, SQL Level, AF Min Level, Mic Gain, Battery Voltage, Horn, Signal Moni, Lone Worker** and **System Info**.

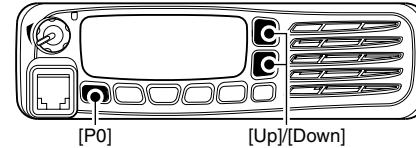

- ④ Hold down [P0] for 1 second to turn the power OFF, then turn the power ON again to exit the User Set mode.

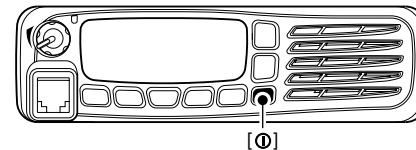

The User Set mode is also available using a programmable key. Please refer to page 7 [User Set Mode] section for instructions regarding using the key assigned to the User Set Mode.

[User Set Mode] allows for quick item selection. Set “Enable” for the often used items using the CS-F3160/F5060 (dPMR) CLONING SOFTWARE. Ask your dealer for details.

■ Emergency transmission

When [Emergency] is held down for the pre-programmed time period, the emergency call is transmitted once, or repeatedly*, on the specified emergency channel.

* Depending on the pre-programmed settings.

A repeat emergency call is automatically transmitted until you turn the power OFF. Depending on the pre-programmed settings, receiving a matching 5-tone code cancels the transmission.

When no emergency channel is specified, the call is transmitted on the operating channel.

If you want to cancel the Emergency function, hold down [Emergency] for the pre-programmed time period again before transmitting the call.

If your transceiver is programmed for Silent operation, you can transmit emergency calls without the beep sounding and the LED indicator lighting.

 **IMPORTANT:** We recommend that you have an emergency channel to provide reliable emergency calls. Ask your dealer for details.

◇ NOTES

Depending on the pre-programmed settings, the following functions are automatically activated.

• Auto TX function

After an emergency call transmission, audio from the microphone is automatically transmitted for the pre-programmed time period.

• The HM-148G or HM-152 HAND MICROPHONE is required.

• Auto RX function

The transceiver stands by in the 'Audible' (unmute) mode for the pre-programmed time period, after the emergency call transmission.

■ Scrambler function

The Voice Scrambler function provides private communication between stations. All versions have a built-in frequency inversion type scrambler. Moreover, the optional Rolling or Non-rolling type can be used.

- Push [Scrambler] to turn the Voice Scrambler function ON or OFF.
 - “” appears when the function is ON.

■ Stun function

The dispatcher can send a signal that will stun, kill or revive your transceiver.

When a Stun command is received, the transceiver becomes unusable. In that case, receiving a Revive command or inputting the password* (p. 8) is necessary to operate the transceiver again.

When a Kill command is received, the transceiver becomes unusable (the transceiver switches to the cloning required condition). In that case, cloning the transceiver is necessary to operate the transceiver again.

* Depending on the pre-programmed settings.

 See the operating guide for details of the Stun function with the BIIS and dPMR system operations. Ask your dealer for details.

■ Priority A channel selection

When one of the following operations is performed, the transceiver automatically selects the Priority A channel.

• Turning the power ON

The Priority A channel is selected each time the transceiver power is turned ON.

• Auto Reset

The Priority A channel is selected when the Auto Reset timer ends.

• OFF hook

The Priority A channel is selected when you take the microphone OFF hook.

■ Forced Narrow function

Depending on the pre-programmed settings, you can turn the Forced Narrow function ON or OFF.

When the function is ON, the channel width becomes Narrow regardless of the channel setting, the [Wide/Narrow] key operation, repeater setting, or PC control command.

To activate or cancel the Forced Narrow function, turn the power ON while holding down both [P1] and [PTT].

Depending on the pre-programmed settings, the Forced Narrow function is initially turned ON by your dealer.

■ Automatic Key Lock function

When the transceiver has a key assigned to Lock, the Automatic Key Lock function can be used.

When no operation occurs during the pre-programmed time period, the function automatically activates the Key Lock function.

When the Key Lock function is ON, hold down [Lock] until "LOCK OFF" is displayed to turn it OFF.

■ Power Off Emergency function

When the transceiver has a key assigned to Power OFF Emergency, you can use the function.

This function makes the transceiver transmit emergency calls, even though it appears to be powered OFF.

To activate the Power OFF Emergency function, turn the power OFF while holding down [Power OFF Emergency].

When the function is activated, any key operation, the ON/OFF Hook and Lone Worker functions become invalid. The beep, LED indicator, display and speaker are turned OFF as well.

On the other hand, the transceiver can transmit emergency calls according to the pre-programmed emergency settings. Depending on the pre-programmed settings, the Ambience Listening function can also be used. (dPMR operation only)

To cancel the Power OFF Emergency function and restore the transceiver, turn the power ON.

■ Rear panel connection

◇ For mobile operation

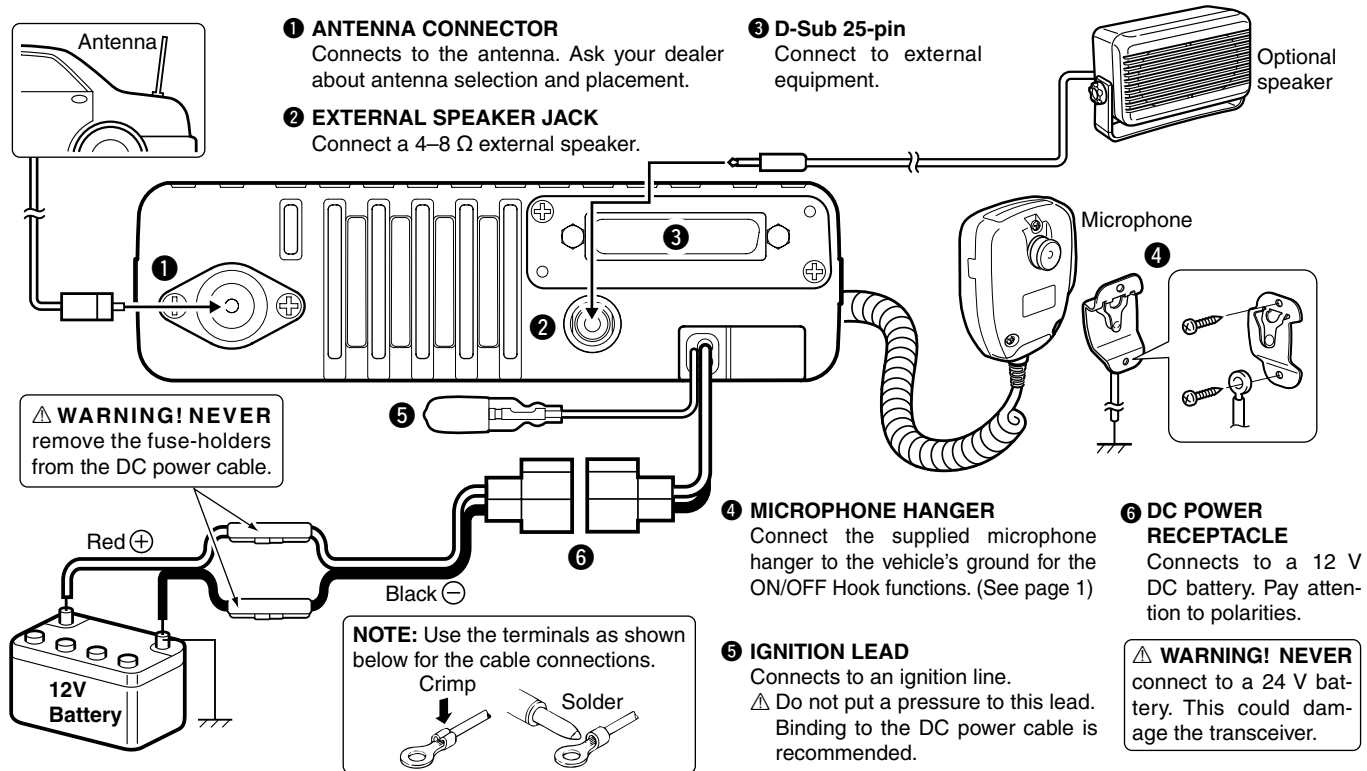







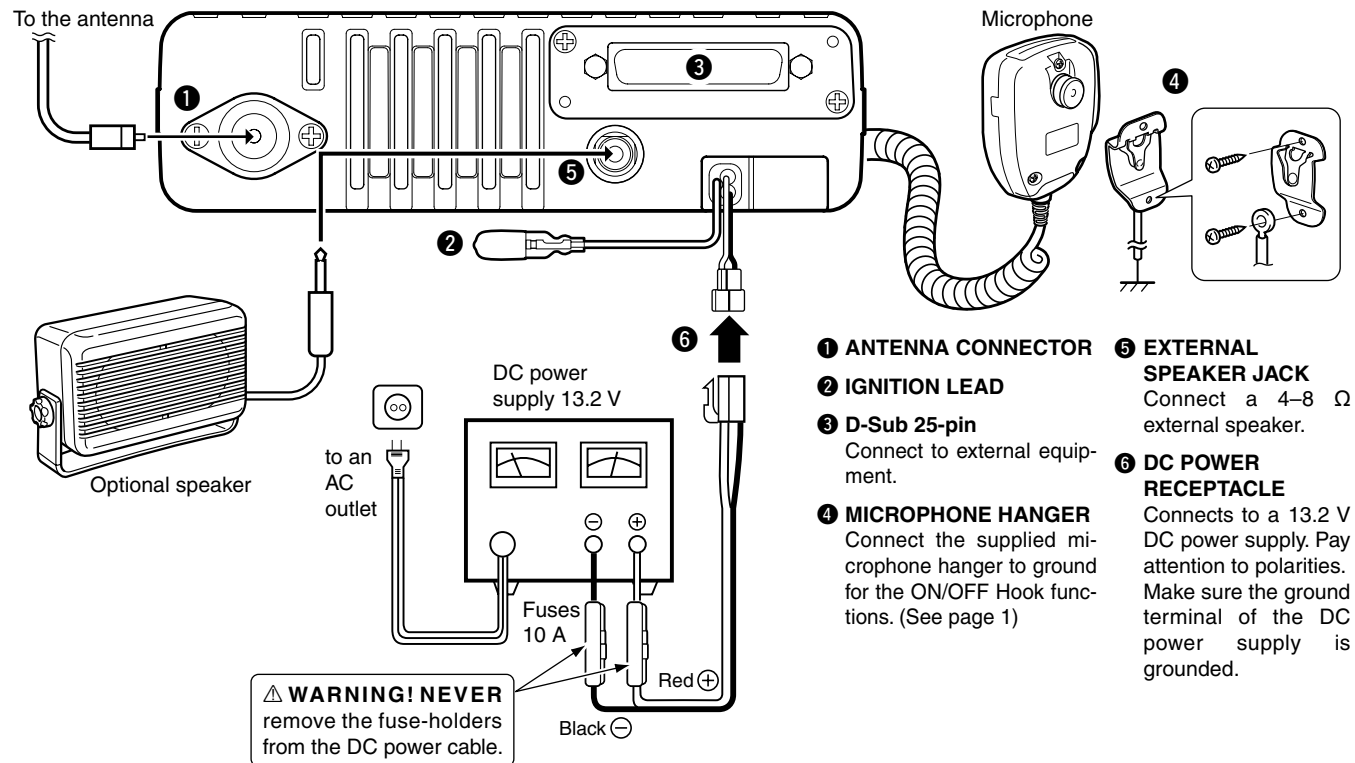

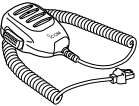

3 CONNECTION AND MAINTENANCE

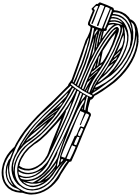
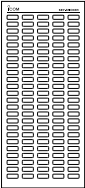
■ Rear panel connection (Continued)

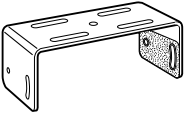
◇ For base station operation



■ Supplied accessories

<p>Microphone</p> 	<p>Microphone hanger and screw set</p> 	<p>Microphone hanger cable</p> 
<p>DC power cable</p> 	<p>Function name stickers*¹</p> 	<p>Sponges*²</p> 
<p>Mounting bracket</p> 	<p>Flat washers</p> 	<p>Bracket bolts</p> 
	<p>Spring washers</p> 	<p>Mounting screws (5×12)</p> 
	<p>Nuts</p> 	<p>Self-tapping screws (5×16)</p> 

*¹ Used for labelling the programmable function keys according to their assigned functions.

*² Used for optional unit installation. Ask your dealer for details.

■ Mounting the transceiver

The universal mounting bracket supplied with your transceiver allows overhead or dashboard mounting.

- Mount the transceiver securely with the 4 supplied screws to a thick surface which can support more than 1.5 kg.

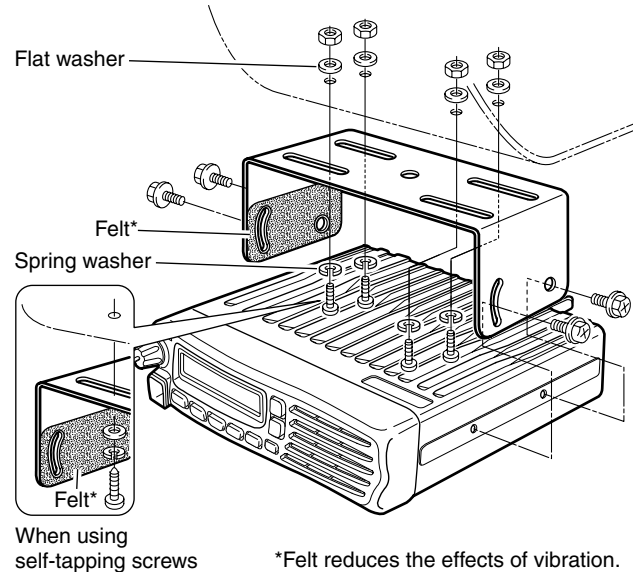

3 CONNECTION AND MAINTENANCE

■ Antenna

A key element in the performance of any communication systems is the antenna. Contact your dealer about antennas and the best places to mount them.

■ Fuse replacement

A fuse is installed in each fuse holder of the supplied DC power cable. If a fuse blows, or the transceiver stops functioning, track down the source of the problem, have it repaired, and replace the damaged fuse with a new rated one.

□ Fuse rating: 10 A

USE a 10 A fuse of the same type only.

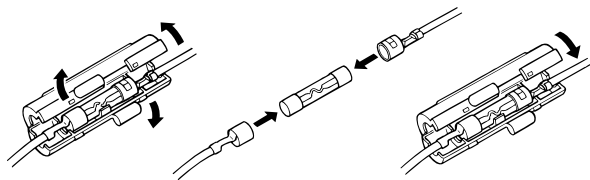

■ Cleaning

If the transceiver becomes dusty or dirty, wipe it clean with a soft and dry cloth.



DO NOT use harsh solvents such as benzine or alcohol, as they damage the transceiver surfaces.

Options

- **RMK-3** SEPARATION KIT + **OPC-607/OPC-608/OPC-609** SEPARATION CABLE

Allows you to install the transceiver main unit separately from the front panel for operating convenience.

OPC-607	: 3 m
OPC-608	: 8 m
OPC-609	: 1.9 m

- **OPC-1132A** DC POWER CABLE

OPC-1132A	: 3 m
-----------	-------

- **SP-10/SP-22/SP-30** EXTERNAL SPEAKERS

Input impedance : 4 Ω

Max. input power : 5 W (SP-10/SP-22), 40 W (SP-30)

SP-10 : For all-round mobile operation.

SP-22 : Compact and easy-to-install.

SP-30 : High input power level.

- **HM-152/HM-152T/HM-148G/HM-148T** HAND MICROPHONES

HM-152 : Hand microphone

HM-152T : DTMF microphone

HM-148G : Self grounding heavy duty microphone

HM-148T : Self grounding heavy duty microphone with 10-keypad

The 10-keypad of this microphone can be used for the DTMF code transmission only.

- **SM-25** DESKTOP MICROPHONE

- **UT-96R** 5TONE UNIT

Provides 5-tone decoder capabilities.

- **UT-108R** DTMF DECODER UNIT

Provides DTMF decoder capabilities.

- **UT-109R/UT-110R** SCRAMBLER UNITS

Non-rolling type (UT-109R)/Rolling type (UT-110R) voice scrambler unit provides high communication security.

Approved Icom optional equipment is designed for optimal performance when used with an Icom transceiver.

Icom is not responsible for the destruction or damage to an Icom transceiver in the event it is used with equipment that is not manufactured or approved by Icom.

Some options may not be available in some countries. Please ask your dealer for details.



We Icom Inc. Japan
1-1-32, Kamiminami, Hirano-ku
Osaka 547-0003, Japan

Declare on our sole responsibility that this equipment complies with the essential requirements of the Radio and Telecommunications Terminal Equipment Directive, 1999/5/EC, and that any applicable Essential Test Suite measurements have been performed.

Kind of equipment : VHF TRANSCEIVER

Type-designation : **IC-F5062**
(Variant name) : **IC-F5062D)**

Version (where applicable):

This compliance is based on conformity with the following harmonised standards, specifications or documents:

- i) EN 60950-1 2001
- ii) EN 301 489-1 v1.4.1 (August 2002)
- iii) EN 301 489-5 v1.3.1 (August 2002)
- iv) EN 300 086-2 v1.1.1 (March 2001)
- v) EN 300 219-2 v1.1.1 (March 2001)
- vi) EN 300 113-2 v1.3.1 (December 2003)
- vii) EN 301 166-2 v1.1.1 (December 2001)

136-174 MHz 12.5 KHz/25 KHz
136-174 MHz 12.5 KHz/20 KHz
136-174 MHz 6.25 KHz

DECLARATION OF CONFORMITY

CE0168 ⚠

Düsseldorf 15th Feb. 2008
Place and date of issue

Icom (Europe) GmbH
Himmelgeister straÙe 100
D-40225 Düsseldorf

Authorized representative name

Y. Furukawa
General Manager



Signature

Icom Inc.



The IC-F5062D and IC-F6062D comply with the essential requirements of the European Radio and Telecommunication Terminal Directive 1999/5/EC.



This warning symbol indicates that this equipment operates in non-harmonised frequency bands and/or may be subject to licensing conditions in the country of use. Be sure to check that you have the correct version of this radio or the correct programming of this radio, to comply with national licensing requirement.



**DECLARATION
OF CONFORMITY**

We Icom Inc. Japan
1-1-32, Kamiminami, Hirano-ku
Osaka 547-0003, Japan

CE0168

Declare on our sole responsibility that this equipment complies with the essential requirements of the Radio and Telecommunications Terminal Equipment Directive, 1999/5/EC, and that any applicable Essential Test Suite measurements have been performed.

Düsseldorf 15th Feb. 2008
Place and date of issue

Kind of equipment : UHF TRANSCEIVER

Type-designation : **IC-F6062**
(Variant name : **IC-F6062D)**

Icom (Europe) GmbH
Himmelgeisterstraße 100
D-40225 Düsseldorf
Authorized representative name

Version (where applicable):

400-470 MHz 12.5 KHz/25 KHz
400-470 MHz 12.5 KHz/20 KHz
400-470 MHz 6.25 KHz

Y. Furukawa
General Manager

This compliance is based on conformity with the following harmonised standards, specifications or documents:

- i) EN 60950-1 2001
- ii) EN 301 489-1 v1.4.1 (August 2002)
- iii) EN 301 489-5 v1.3.1 (August 2002)
- iv) EN 300 086-2 v1.1.1 (March 2001)
- v) EN 300 219-2 v1.1.1 (March 2001)
- vi) EN 300 113-2 v1.3.1 (December 2003)
- vii) EN 301 166-2 v1.1.1 (December 2001)

Signature

Icom Inc.

4 DOC

• List of Country codes (ISO 3166-1)

	Country	Codes		Country	Codes
1	Austria	AT	18	Liechtenstein	LI
2	Belgium	BE	19	Lithuania	LT
3	Bulgaria	BG	20	Luxembourg	LU
4	Croatia	HR	21	Malta	MT
5	Czech Republic	CZ	22	Netherlands	NL
6	Cyprus	CY	23	Norway	NO
7	Denmark	DK	24	Poland	PL
8	Estonia	EE	25	Portugal	PT
9	Finland	FI	26	Romania	RO
10	France	FR	27	Slovakia	SK
11	Germany	DE	28	Slovenia	SI
12	Greece	GR	29	Spain	ES
13	Hungary	HU	30	Sweden	SE
14	Iceland	IS	31	Switzerland	CH
15	Ireland	IE	32	Turkey	TR
16	Italy	IT	33	United Kingdom	GB
17	Latvia	LV			

About e-marking: Detailed installation notes for Icom mobile transceivers to be fitted into vehicles are available. Please contact your Icom dealer or distributor.

Count on us!

< Intended Country of Use >

AT BE CY CZ DK EE
FI FR DE GR HU IE
IT LV LT LU MT NL
PL PT SK SI ES SE
GB IS LI NO CH BG
RO TR HR

A-6841H-1EU
Printed in Japan
© 2010 Icom Inc.

Printed on recycled paper with soy ink.

Icom Inc.

1-1-32 Kamiminami, Hirano-ku, Osaka 547-0003, Japan